

GL: 030-T-

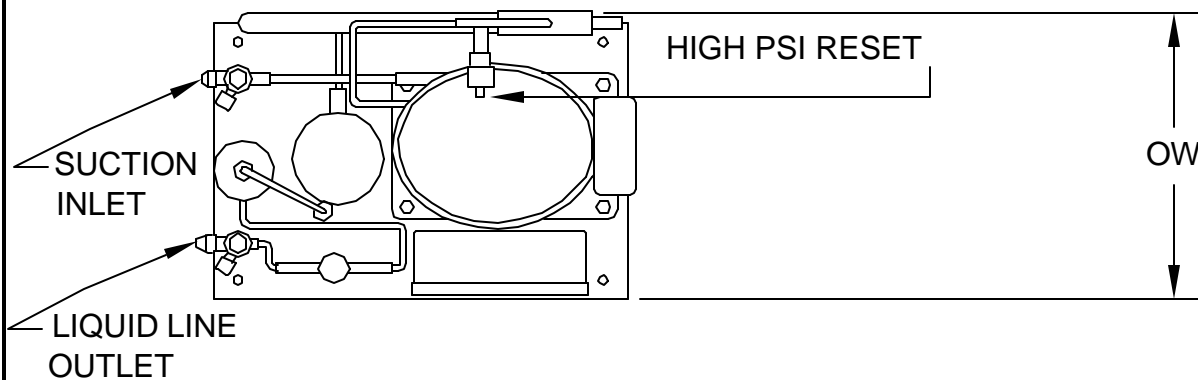

FEATURE	SPECIFICATION	
MODEL	GL: 030-T-	NOTES
HORSEPOWER REFRIGERANT	1/3 R-134A	1350 BTU @ -10 deg F EVAP.
OVERALL WIDTH BASE DEPTH WEIGHT OVERALL HEIGHT	11.80 (295mm) 17.00 (425mm) 48 LBS/22 Kg 11.00 (275mm)	
SUCTION INLET LIQUID LINE OUTLET WATER INLET WATER OUTLET	3/8" SAE FLARE 1/4" SAE FLARE 1/2" HOSE 1/2" HOSE	
VOLTAGE PHASE FREQUENCY (Hz) LRA RLA WEIGHT	115 VAC SINGLE 60 40 5.9 28 LBS (12.7 Kg)	

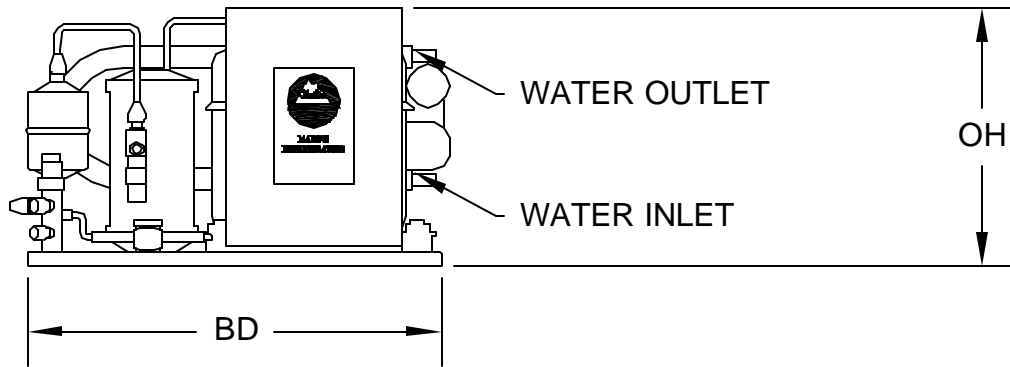